

Stapler:

10.2180 1 TN-MS 280

Geschirrtteile:

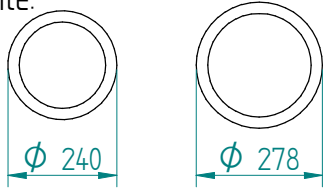

von bis

Abmessungen: Gewicht (Leer): 24 kg

A x B = Wagen, excl. Stoßecken

E x F = Wagen, incl. Stoßecken

H = Wagenhöhe

S = effektive Stapelhöhe

T = Höhe mit Schiebegriff

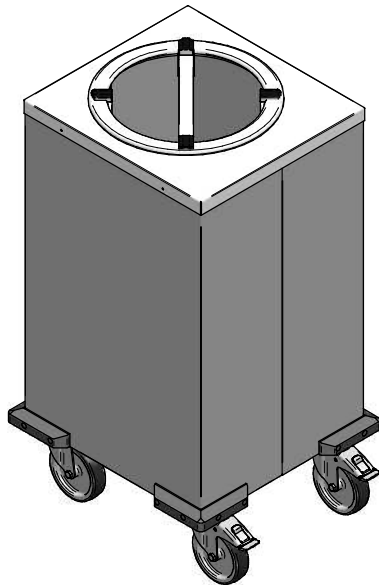

DU

VR :

IR :

MOBILE CONTAINING

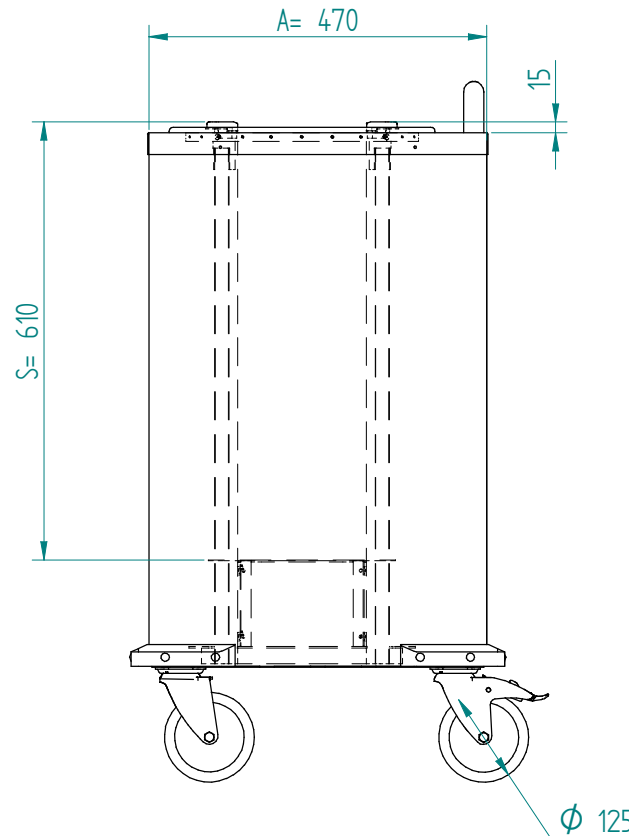
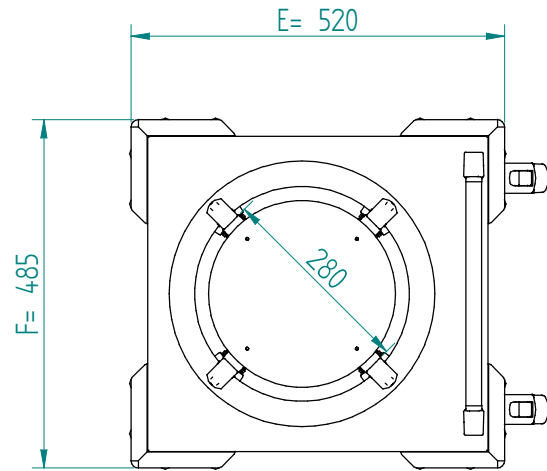

4 Lenkrollen, 2 mit Feststeller

Zubehör, zusätzlich bestellen;

Schiebegriff: 90.5000

Cns Deckel: 92.5085

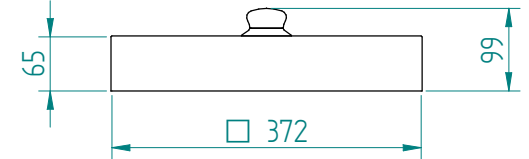

Kunststoff Deckel: 91.5031

