

Stapler: 20.2740 1 THN-MS 310

Heizkörper 230V-600W

Geschirrtteile:

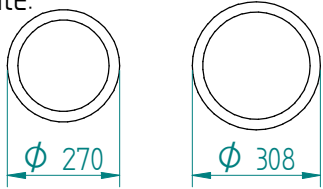

von bis

Abmessungen: Gewicht (Leer): 36 kg

A x B = Wagen, excl. Stoßecken

E x F = Wagen, incl. Stoßecken

H = Wagenhöhe

S = effektive Stapelhöhe

T = Höhe mit Schiebegriff

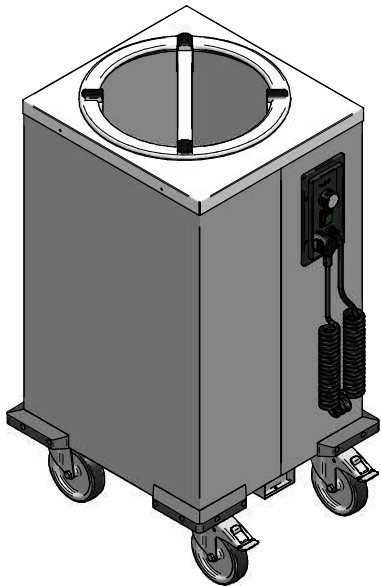

DU

VR :

IR :

**MOBILE CONTAINING**

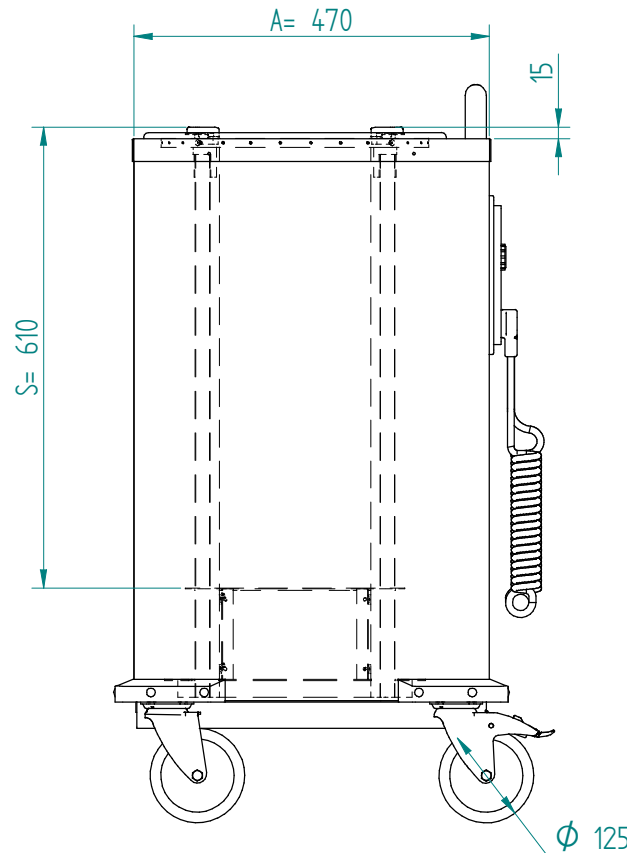
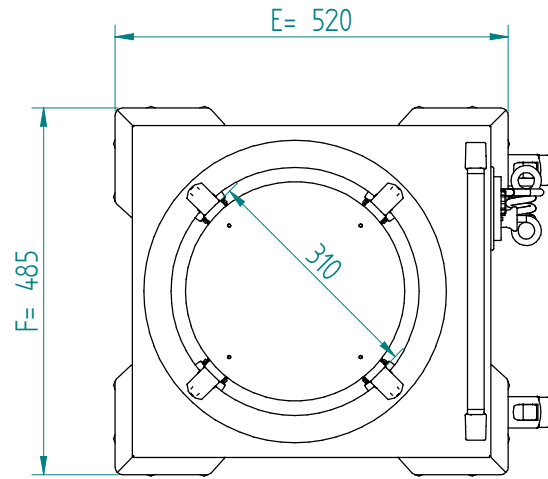

4 Lenkrollen, 2 mit Feststeller

Zubehör, zusätzlich bestellen;

Schiebegriff: 90.5000

Cns Deckel: 92.5095

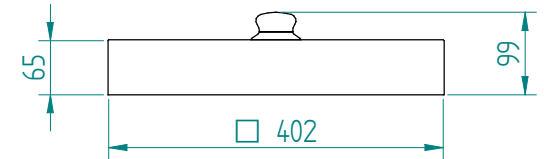

Kunststoff Deckel: 91.5041

